

# SPR30UIMX

Range size	30"
Oven energy source	Electricity
Cooktop type	Induction
Main oven	Thermo-ventilated
EAN code	8017709308964











## Aesthetic

Series	Professional	No. of controls	6
Color	Stainless steel	Silkscreen color	Black
Design	Flush mounted	Handle	Robust knurled handle
Control panel finish	Stainless steel	Handle color	Brushed stainless steel
Control knobs	Pro-style control knobs	Logo	Assembled
Controls color	Stainless steel	Logo position	Fascia below the oven
Display	Touch		

## Programs / Functions

No. of cooking functions 8

### Traditional cooking functions

 Static	 Fan-assisted	 True European convection
 Small grill	 Large grill	 Large grill + Fan
 Convection bottom	 Pizza	

### Cleaning functions

 VaporClean

### Other functions

 Defrost by time

## Cooktop options

Multizone Option            Yes

## Cooktop technical features



**Cooking zones** 4

Front-left - 1.30 kW - Booster 1.40 kW  
 Rear-left - 2.30 kW - Booster 3.00 kW  
 Front-right - 2.30 kW - Booster 3.00 kW  
 Rear-right - 1.30 kW - Booster 1.40 kW

**Cooking zones with  
Booster**                    4

**Selected zone indicator**    Yes

**Residual heat indicator**    Yes

**Automatic switch-off in  
case of over-heating**    Yes

**Automatic pan  
detection**                    Yes

## Main Oven Technical Features



**No. of lights**                    2

**Fan number**                    1

**Volume**                         4.56 cu. ft.

**Cavity material**                EverClean enamel

**No. of shelves**                 6

**Shelves type**                    Metal racks

**Light type**                        Halogen

**Light Power**                    40 W

**Time setting**                    Minute minder

**Full-glass inner door**        Yes

**Total no. of door glasses** 3

**Cooling system**                Tangential

**Bottom heating element  
- Power**                        1700 W

**Upper heating element -  
Power**                            1200 W

**Grill power**                        1700 W

**Large grill - Power**            2900 W

**Circular heating element  
- Power**                        2700 W

**Grill type**                         Electric

**Soft Close system**             Yes

## Main oven options

**Minimum Temperature**    66 °F

**Maximum temperature**    500 °F

## Accessories included for main oven and cooktop

**Oven grid with back-  
stop, tray support**            2

**Meat Probe**                    1

## Electrical Connection

**Circuit breaker** 40 A  
**Voltage** 208/240 V  
**Type of electric cable installed** Yes, Double phase

**Power cord length** 47 1/4 "  
**Frequency** 60 Hz  
**Terminal block** 3 pins

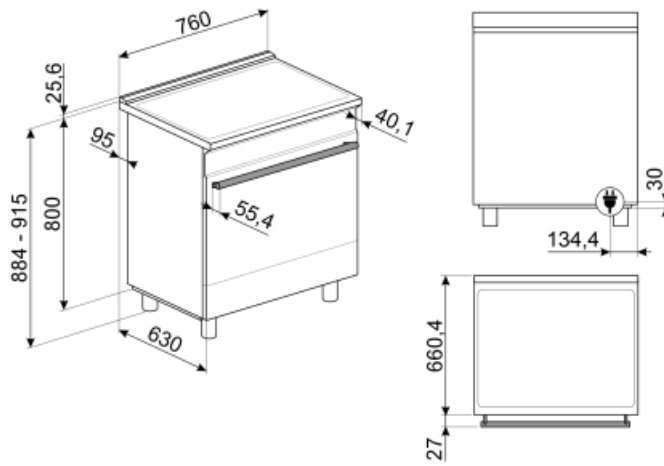

## Not included accessories

### AIRFRY9

Air fryer rack AIRFRY . Ideal for recreating traditional frying in the oven, but with fewer calories and less fat. It allows you to cook quickly and simply dishes such as French fries, fried vegetables and fish, ensuring perfect browning and crispiness.



### PRTX

Refractory pizza stone with handles. D=35cm Not suitable for microwave ovens. Suitable for gas ovens, to be put on the griddle.



### GT3T



### SCRP

Induction and ceramic hobs and teppanyaki scraper



### TPKPLATE

Universal plate for induction, gas, ceramic and electric hobs. Non-stick surface ideal for cooking fish, eggs and vegetables. Dimensions: 410 X 240 mm.



### SFLK1

Child lock

### GRILLPLATE

Universal griddle for induction, gas, ceramic and electric hobs. Non-stick surface ideal for cooking meat, cheese and vegetables. Dimensions: 410 x 240 mm.



### BBQ9



### KITTKSPR30

Plinth, 3 sides, 900mm , SPR cookers 30", black





















### PALPZ

Pizza shovel with fold away handle width: 315mm length : 325mm



## Symbols glossary (TT)

 <p><b>Power booster:</b> option allows the zone to work at full power when very intense cooking is necessary.</p>	 <p><b>Air cooling system:</b> to ensure a safe surface temperatures.</p>
 <p><b>Defrost by time:</b> with this function the time of thawing of foods are determined automatically.</p>	 <p><b>Triple glazed doors:</b> Number of glazed doors.</p>
 <p><b>Enamel interior:</b> The enamel interior of all Smeg ovens have a special antacid lining which helps keep the interior clean by reducing the amount of cooking grease adhering to it.</p>	 <p><b>Circogas:</b> In gas ovens the fan distributes the heat quickly and evenly throughout the oven cavity, avoiding flavour transfer when cooking a number of different dishes at the same time. In electric ovens this combination completes cooking more quickly of foods that are ready on the surface, but that require more cooking inside, without further browning.</p>
 <p><b>Fan with upper and lower elements:</b> The elements combined with the fan aim to provide more uniform heat, a similar method to conventional cooking, so pre-heat is required. Most suitable for items requiring slow cooking methods.</p>	 <p><b>Upper and lower element only:</b> a traditional cooking method best suited for single items located in the centre of the oven. the top pf the oven will always be hottest. Ideal for roast, fruit cakes, bread etc.</p>
 <p><b>Circulaire:</b> The combination of the fan and circular element around it gives a hot air cooking method. This provides many benefits including no preheat if cook time is more than 20 minutes, no flavour transfer when cooking different foods at the same time, less energy, and shorter cook times. Good for all types of food.</p>	 <p><b>Grill element:</b> Using of grill gives excellent results when cooking meat of medium and small portions, especially when combined with a rotisserie (where possible). Also ideal for cooking sausages and bacon.</p>
 <p><b>Half grill:</b> For rapid cooking and browning of foods. Best results can be obtained by using the top shelf for small items, the lower shelves for larger ones, such as chops or sausages. For half grill heat is generated only at the centre of the element, so is ideal for smaller quantities.</p>	 <p><b>Fan with grill element:</b> The fan reduces the fierce heat from the grill, providing an excellent method of grilling various foods, chops, steaks, sausages etc. giving even browning and heat distribution, without drying out the food. The top two levels recommended for use, and the lower part of the oven can be used to keep items warm at the same time, an excellent facility when cooking a grilled breakfast. Half grill (centre portion only) is ideal for small quantities of food.</p>
 <p><b>Pizza function:</b> The simultaneous operation of three elements ensures an optimum cooking facility when used with the Smeg pizza stone.</p>	 <p><b>Overheat protection:</b> The safety system that automatically turns off the hob in case of overheating of the control unit.</p>
 <p><b>Induction:</b> The work of these hobs is based on the principle of electromagnetic induction. The heat is generated directly in the bottom of the pan during its contact with the hob.</p>	 <p><b>All glass inner door:</b> All glass inner door, a single flat surface which is simple to keep clean.</p>
 <p><b>Side lights:</b> Two opposing side lights increase visibility inside the oven.</p>	 <p><b>Indication of residual heat:</b> After the glass ceramic hob is switched off the residual heat indicator shows which of the heating zones still remains hot. When the temperature drops below 60 ° C, the indicator goes out.</p>



The oven cavity has 6 different cooking levels.



Soft close: all models are equipped with advanced function of smooth closing of the door, which allows the device to close smoothly and quietly.



Vapor Clean: a simple cleaning function using steam to loosen deposits in the oven cavity.