



INSTALLATION, USE & CARE MANUAL

30" BUILT-IN OVEN

F30PROXV (F7..PAB1XE.UA)
PROFS30XV (F7..PAB1XE.UP)
MASFS30XV (F7..PAC1XE.UP)





BERTAZZONI SpA
Via Palazzina 8
42016 Guastalla RE
ITALY

WWW.BERTAZZONI.COM

FROM THE DESK OF THE PRESIDENT

Dear new owner of a Bertazzoni product,

I want to thank you for choosing one of our beautiful products. We know that you have many brands and products to choose from and we are thrilled that you have decided to take one of our products into our home.

We take as much pride in making our products as we hope you will in owning them. My family started manufacturing cooking appliances in 1882. Each of our products is a blend of Italian design finesse and superior appliance technology. While we will never replace your unique talent at preparing delicious dishes, we try our best at making cooking easier, more effective and more fun.

Our appliances are designed according to the strictest safety and performance standard for the European and the North American market. We follow the most advanced manufacturing techniques. Each appliance leaves the factory after thorough quality inspection and testing. Our distributors and our service partners are ready to answer any questions you may have regarding how to install, use and care for your Bertazzoni product.

This manual will help you learn to use the product safely and most effectively and care for it so that it may give you the highest satisfaction for years to come.

The manual also includes directions for the professional installer that will install the product in your home. We recommend using factory-trained professionals for the delicate task of installing and testing appliances in your home. Please call Customer Service if you need help locating a factory-trained professional installer in your area.

Please keep this manual handy for future use.

Grazie!

TABLE OF CONTENTS

APPLIANCE INFORMATION	4
WARRANTY AND SERVICE	Errore. Il segnalibro non è definito.
IMPORTANT SAFETY INSTRUCTIONS	6
PRODUCT SPECIFICATION	9
INSTALLATION INSTRUCTIONS	10
CARING FOR THE ENVIRONMENT	10
WIRING DIAGRAM	11
CUT-OUT DIMENSIONS	12
INSTALLING THE OVEN	13
GETTING STARTED	14
USING THE LCD DISPLAY	15
BEFORE USING THE OVEN	15
OVEN COOKING	16
USING THE LCD DISPLAY	16
OVEN FUNCTIONS SELECTOR	18
TEMPERATURE/CLEAN SELECTOR	18
OVEN OPERATION	18
COOKING MODES GUIDE	19
TIPS FOR BEST RESULTS - BAKING	20
TIPS FOR BEST RESULTS - WARMING	20
TIPS FOR BEST RESULTS - DEHYDRATE	21
SELF-CLEANING CYCLE	22
CLEANING THE OVEN	24
REPLACING THE OVEN LIGHTS	25
TROUBLESHOOTING GUIDE	26

APPLIANCE INFORMATION

MODEL

DATE INSTALLED

DEALER

INSTALLER

SERVICER

Please kindly register on our web site www.bertazzoni.com to validate your new product warranty and help us to assist you better in case of any inconvenience.

TWO YEAR LIMITED WARRANTY

The warranties provided by Bertazzoni Spa in this statement apply exclusively to Bertazzoni appliances and accessories sold as new products to the original owner by a Bertazzoni authorized distributor, retailer, dealer or service center and installed in the United States and Canada. The warranties provided in this statement are not transferable and have validity from the date of installation.

COVERAGE INFORMATION

Bertazzoni SpA will repair or replace any component part which fails or proves defective due to materials and/or workmanship within 2 years from the date of installation and under conditions of normal residential use. Repair or replacement will be free of charge, including labor at standard rates and shipping expenses. Repair service must be performed by a Bertazzoni Authorized Service Center during normal working hours.

COSMETIC WARRANTY

Bertazzoni will cover parts showing cosmetic defects in material and workmanship for a period of thirty (30) days from date of installation of the unit. This coverage will include scratches, stains, surface imperfections on stainless steel, paint and porcelain, with the exclusion of slight differences in color due to materials and painting/enamelling technologies.

Exclusions are labor costs, B stock items, out-of-box appliances and display units.

HOW TO OBTAIN SERVICE

To obtain warranty service please contact Bertazzoni Customer Service at the numbers below and provide model number, serial number and date of purchase.

ENGLISH 866 905 0010 - FRANCAIS 800 561 7265

Save proof of original purchase or of original installation to establish warranty period. Copy of the product serial tag is affixed to the back cover of the instruction manual.

WHAT IS NOT COVERED

- 1 The product used in any commercial application
- 2 Repair service provided by other than a Bertazzoni authorized service agency.
- 3 Damage or repair service to correct service provided by an unauthorized agency or the use of unauthorized parts.
- 4 Installation not in accordance with local electrical codes or plumbing codes.
- 5 Defects or damage due to improper storage of the product.
- 6 Defects or damage or missing parts on products sold out of the original factory packaging or from displays.
- 7 Service calls or repairs to correct the installation of the product and/or related accessories.
- 8 Service calls to connect, convert or otherwise repair the electrical wiring and/or gas line to properly use the product.
- 9 Service calls to provide instructions on the use of a Bertazzoni product.
- 10 Repair service due to product usage in manner other than what is normal and customary for home use.
- 11 Replacement of wear and tear parts
- 12 Replacement of glasses and light bulbs if they are claimed to have failed later than 30 days after installation and in no case later than 4 months after date of purchase
- 13 Defects and damages arising from accident, alteration, misuse, abuse, improper installation.
- 14 Defects and damages arising from transportation of the product to the home of the owner.
- 15 Defects and damage arising from external forces beyond the control of Bertazzoni SpA such as fire, flood, earthquakes and other acts of God.

In case the product will be installed in a remote area, where certified trained technicians are not reasonably available, the customer will be responsible for the transportation costs for the delivery of the product to the nearest authorized service center or for the displacement costs of a certified trained technician.

Bertazzoni does not assume any responsibility for incidental or consequential damages.

Some states do not allow the exclusion or limitation of incidental or consequential damages, so the above limitation or exclusion may not apply to you. This warranty gives you specific legal rights and you may also have other rights which may vary from state to state or province to province.

IMPORTANT SAFETY INSTRUCTIONS

Read these instructions before installing or using the oven for the first time.

Save these instructions and review them periodically.

Keep the instructions in a safe place and transfer them to any future user.

General

This appliance complies with current safety requirements.

The appliance is intended for domestic use only: cooking, baking, roasting, broiling, defrosting and heating of food. It is not designed for industrial or laboratory use.

Only use the appliance for its intended purpose. Improper use of the appliance can lead to personal injury and property damage. The manufacturer is not liable for personal injury, product or property damage caused by improper use of this oven.

Those who lack physical, sensory or mental abilities, or experience with the appliance should not use it without supervision or instruction by a responsible person.

Children

Children should not be left unattended in an area where the appliance is in use.

Never allow children to hang or lean on any part of the appliance.

CAUTION! Do not store items of interest to children in cabinets above an oven. Children climbing on the oven to reach these items could be injured.

Children should not use the unit without supervision unless its operation has been sufficiently explained so they can use it safely. Children must be able to understand potential hazards or improper operation.

Do not allow children to touch or play in, on or near the oven when it is in operation. The oven gets hot at the oven door glass, the cooling exhaust, the handle and the operating controls. Use extra care to avoid burns.

Installation

Before installation, make sure that the voltage and frequency listed on the data plate correspond with the household's electrical supply to prevent personal injury and/or damage to the appliance. Consult a qualified electrician if in doubt.

Make sure your appliance is properly installed and grounded by a qualified technician.

CAUTION: The appliance must be effectively grounded to guarantee the electrical safety. If in doubt, have the electrical system of the house checked by a qualified electrician. The manufacturer is not liable for damages caused by the lack or inadequacy of an effective grounding system or the failure to adhere to national and local electrical codes.

The oven should not be operated until it has been properly installed.

Installation, maintenance and repair work should be performed by a factory authorized service technician. Work by unqualified persons could be dangerous and may void the warranty.

Before installation or service, disconnect the power supply to the work area by removing the fuse, tripping the circuit breaker or shutting off the power main.

WARNING! ELECTRICAL SHOCK HAZARD!

Disconnect electrical power at the circuit breaker box or fuse box before installing the appliance.

Provide appropriate grounding for the appliance.

Use copper conductors only.

Failure to follow these instructions could result in serious injury or death

CAUTION! Label all wires prior to disconnecting when servicing controls. Wiring errors can cause improper and dangerous operation.

Verify proper operation after servicing.

Oven use

WARNING! Ovens can produce high temperatures that can cause burns.

Prevent children from touching the appliance while in use.

Use heat-resistant potholders when placing items in the oven, turning them, or removing them from the oven. The upper heating element and oven racks can become very hot and cause burns.

To prevent burns, always place oven racks at their desired height while the oven is cool.

Open the door carefully to allow hot air or steam to escape before placing or removing food.

To prevent burns, allow the heating element to cool before cleaning by hand.

During the self cleaning function the oven will become very hot. Prevent children from coming in contact with the oven.

Remove all accessories from the oven before starting a self-clean cycle. The high temperatures needed for this program will damage the accessories.

The door gasket is essential for a good seal. Care should be taken not to wear, damage or remove the gasket.

Only clean parts listed in this manual.

CAUTION: Heating elements may be hot even though they are not glowing. During and after use, do not let clothing or other flammable materials come in contact with heating elements or interior surfaces of the oven until they have had sufficient time to cool. External parts of the oven such as the door glass, vents, and the control panel can become hot.

Do not block the exhaust vents.

Aluminum foil should not be used to line the bottom of the oven cavity.

Do not place pots, pans or baking sheets directly on the bottom of the oven cavity.

Do not slide pots or pans on the oven floor. This could scratch and damage the surface enamel.

Do not let metal objects (aluminium foil, pans) or the meat probe come in contact with the heating element.

Do not sit or step on the oven door.

Do not place heavy items on the open oven door.

Only use the food probe supplied with the oven. Contact Bertazzoni Service if you need to purchase a new probe.

To prevent damage, remove the food probe from the oven when it is not being used.

Do not heat unopened containers of food in the oven, pressure may build up and cause them to explode.

Never add water to food on a hot tray or pan, or directly onto food in a hot oven. The steam generated could cause serious burns or scalds.

This oven must only be used for cooking. Do not use it as a dryer, kiln, dehumidifier, etc. Fumes or vapors given off by glues, plastics or flammable liquids and materials could be hazardous.

Never store flammable liquids and materials in, above or under an oven, or near cooking surfaces.

Do not use the appliance to store or dehydrate flammable materials. This is a fire hazard.

Do not use the oven to heat the room.

When baking frozen pizzas or pies, place them on the rack lined with parchment paper. Frozen food like french fries, fish sticks, chicken fingers etc. can be baked on the baking tray.

Always check that food is sufficiently heated. The time required varies depending on a number of factors, such as initial temperature, quantity of food, type and consistency of the food, and recipe. Germs present in the food are killed off only at a sufficiently high temperature (> 158F / 70C) and after a sufficiently long time (10 minutes or

longer). Select a longer cooking time if you are unsure whether the food is thoroughly heated. To ensure temperature is distributed evenly, stir food before serving.

It is recommended to cover all cooked food that is left in the oven to be kept warm. This will prevent moisture from condensing on the interior of the oven.

Be careful when cooking with alcoholic beverages like rum, whiskey, wine etc. The alcohol evaporates at high temperatures but may in rare circumstances combust on the hot heating elements.

Other

Do not use a steam cleaner to clean the oven. Steam could penetrate electrical components and cause a short.

Do not leave the oven unattended when cooking with oils or fats, they are a fire hazard if overheated.

Do not use water on grease fires! Smother the fire with a properly rated dry chemical or foam fire extinguisher.

Be aware of loose or hanging garments while operating the cooktop, they present a fire hazard.

Make certain that the power cords of small appliances do not come in contact with or get caught in the oven door.

Use only dry, heat-resistant potholders. Moist or damp potholders used on hot surfaces may result in steam burns. Do not let potholders come in contact with oils. Do not substitute towels or other bulky items for potholders.

SAVE THESE INSTRUCTIONS AND REVIEW THEM PERIODICALLY.

PRODUCT SPECIFICATION

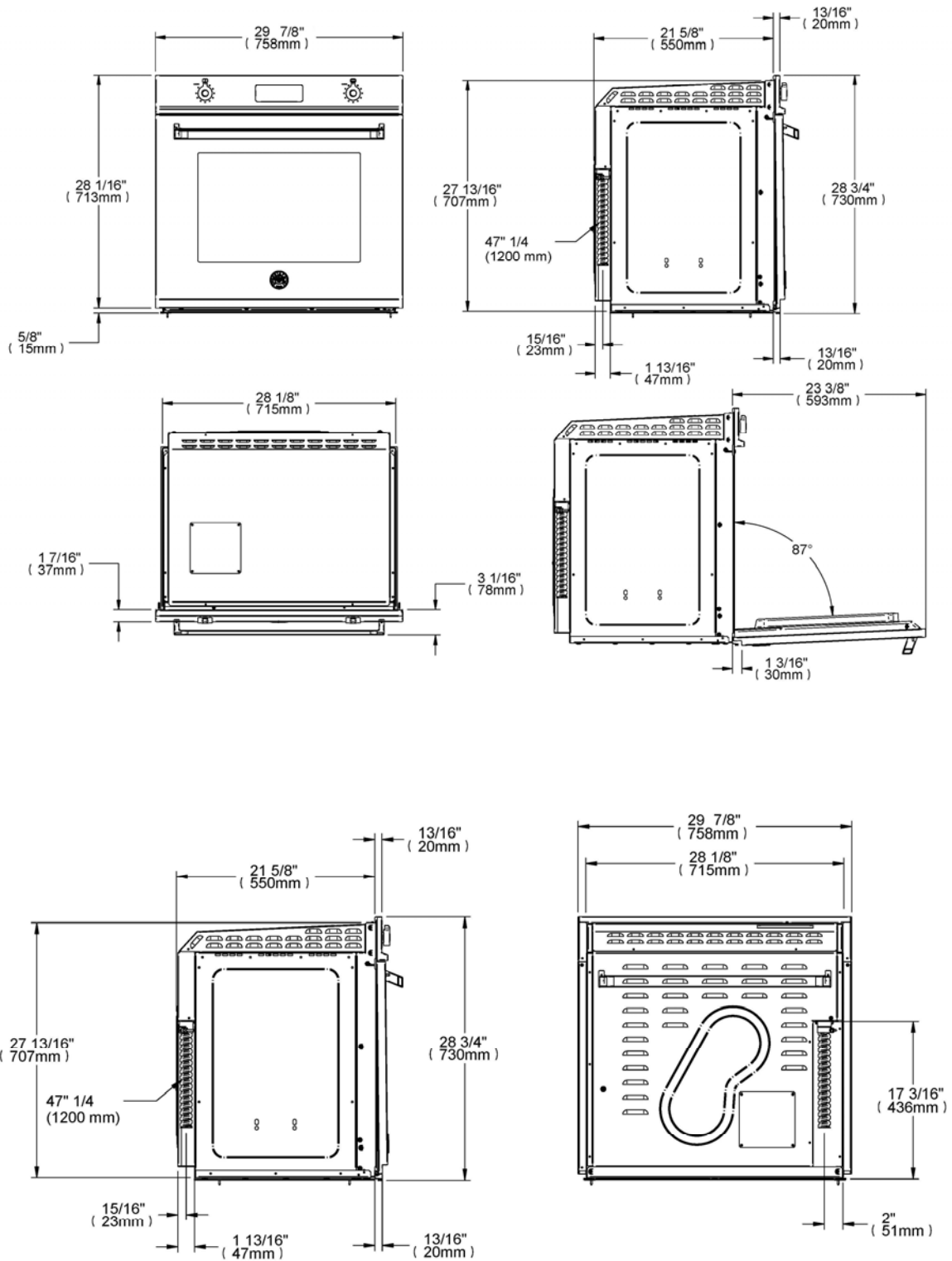

Electrical requirements

120/240V - 5500W (24 A max) or 120/208V – 4400W (21 A max).

Upper heating element 3400W

Lower heating element 2100W

Convection heating elements 2 x 1650W

INSTALLATION INSTRUCTIONS

INSTALLER: PLEASE LEAVE THESE INSTRUCTIONS WITH THE OWNER.

Electrical connection

CAUTION: Before installing the oven, disconnect the power supply by either removing the fuse, shutting off the power main or manually tripping the circuit breaker.

Installation work and repairs should only be performed by a qualified technician in accordance with all applicable codes and standards. Repairs and service by unqualified persons could be dangerous and may void the warranty. The manufacturer is not liable for personal injury, product or property damage caused by serviced performed by unqualified persons.

Before connecting the appliance to the power supply, make sure that the voltage and frequency listed on the data plate correspond with the household electrical supply. This data must correspond to prevent damage to the product. Consult an electrician if in doubt.

Only operate the appliance after it has been installed in a cabinet.

Power supply

The oven is equipped with a 4 ft. (1.2 m.) flexible metal cable with 4 wires ready for connection to a dedicated 3 pole, 4 wire grounded power supply:

120/240Vac: 5500 Watt or 24 A max.

or

120/208Vac: 4400 Watt or 21 A max.

Black wire: connect to L1 (hot)

Red wire: connect to L2 (hot)

White wire: connect to N (neutral)

Green wire: connect to GND (ground)

A dedicated line and junction box should be used to connect the oven to a 30 A circuit.

CARING FOR THE ENVIRONMENT

Disposal of packing materials The cardboard box and packing materials protect the appliance during shipping. Ensure that any plastic wrappings, bags, etc. are disposed of safely and kept out of the reach of children. Danger of suffocation!

Disposal of an old appliance Old appliances may contain materials that can be recycled. Please contact your local recycling authority about the possibility of recycling these materials. Make sure that the appliance presents no danger to children while being stored for disposal. Before discarding an old appliance, unplug it from the outlet and cut off its power cord. Remove any doors to prevent trapping hazards.

WIRING DIAGRAM

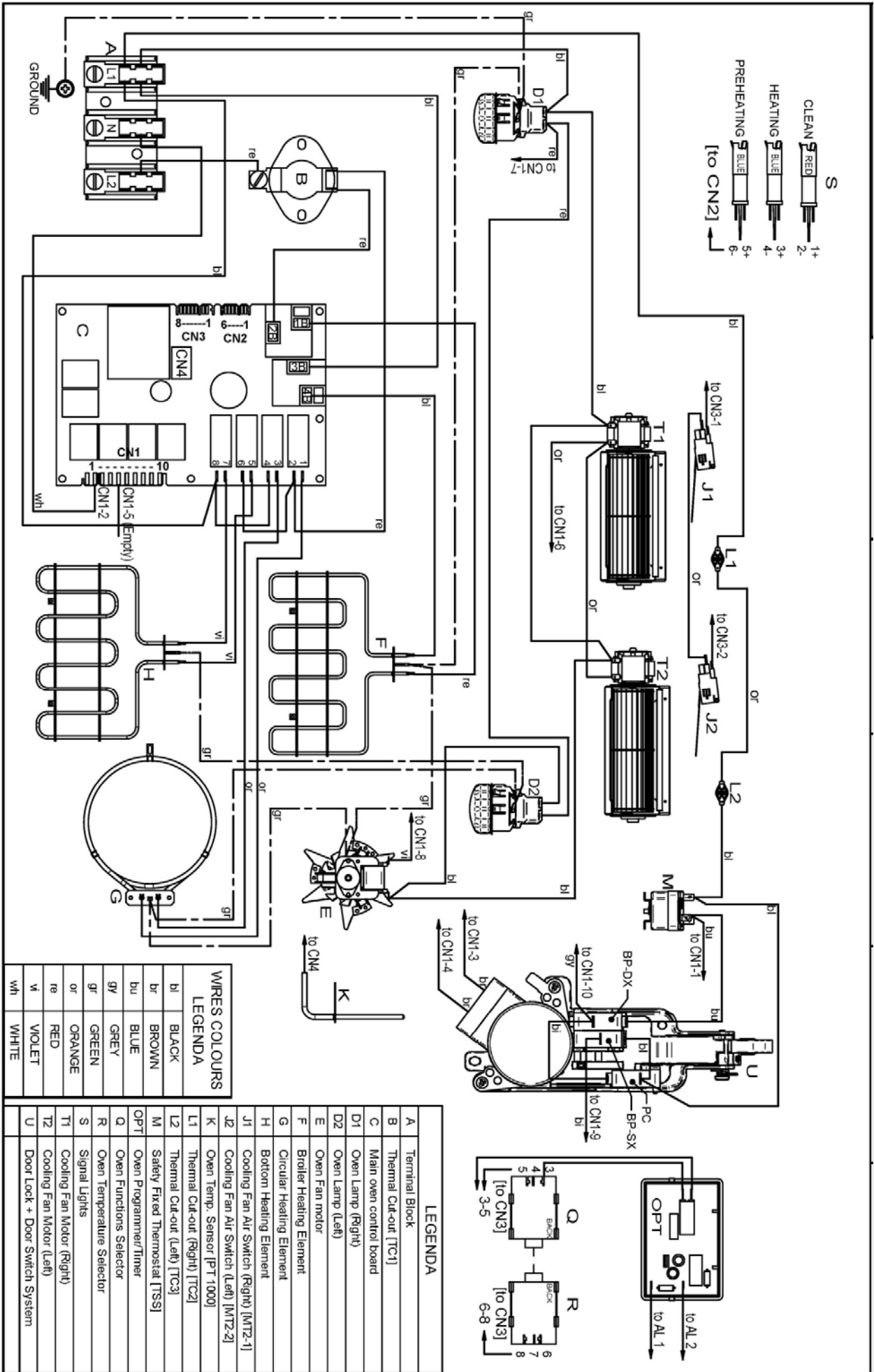

CUT-OUT DIMENSIONS

IMPORTANT

Kitchen cabinets shall be made of materials capable of withstanding temperatures at least 117°F (65°C) above room temperature in order to avoid possible damage to the cabinets during oven usage.

The oven must be installed into cabinetry and be supported from underneath.

The oven vent at the bottom of the door must be left unobstructed.

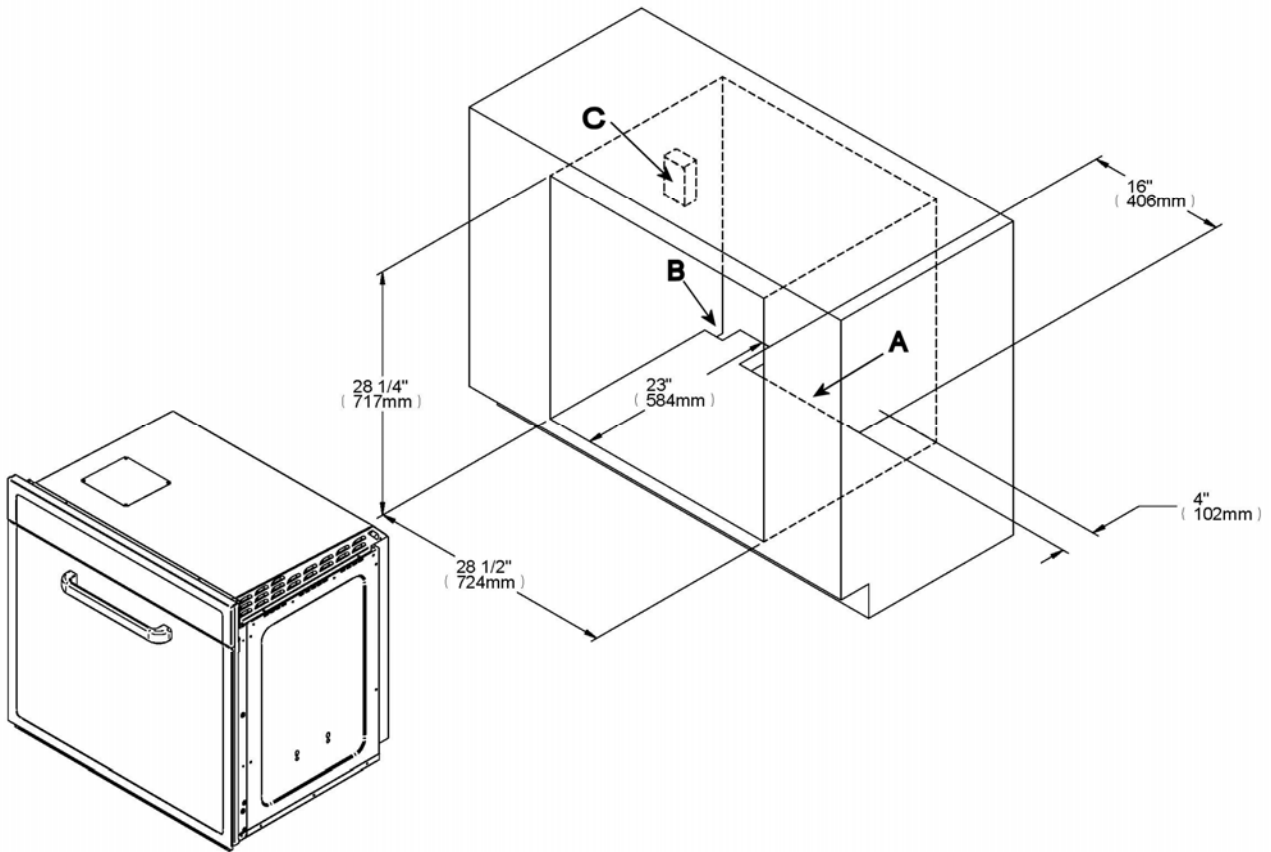

- A** Vent cut-out 16" x 4" (406mm x 102mm) in the base of the cabinet
- B** Cut-out for power cord min. 1" x 1" (2.54 x 2.54 cm.)
- C** Electrical connection box

INSTALLING THE OVEN

STEP 1

Fix the supplied skid plates to the cabinet floor.

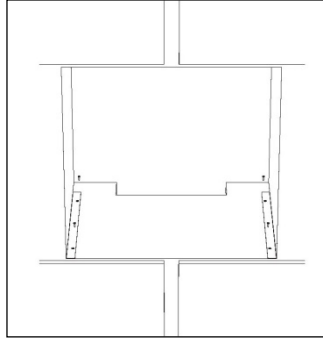

STEP 2

Prepare the door for removal. Flip up the locking clamps on each door hinge. Slowly shut the door until the protruding clamps stop the movement. Pull oven door upwards and remove.

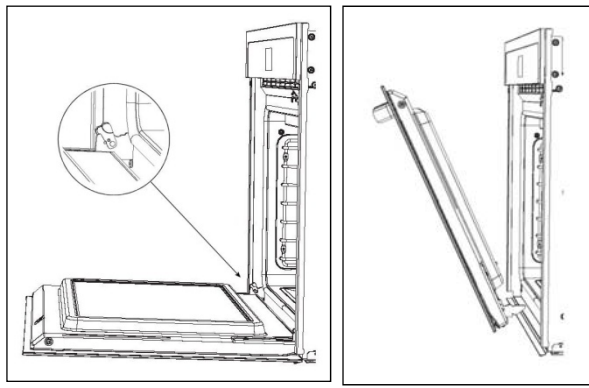

STEP 3

Connect the oven to the electrical supply.

STEP 4

Slide the oven into the cabinet and align.

STEP 5

Reinstall the oven door.

STEP 7

Open the oven door and locate the two mounting screw holes in the oven frame. Mark and drill $\frac{1}{4}$ " (6 mm) pilot holes. Secure the oven to the cabinetry by inserting screws through the frame and into the cabinetry. Assemble the supplied screw caps over the screw head to conceal them.

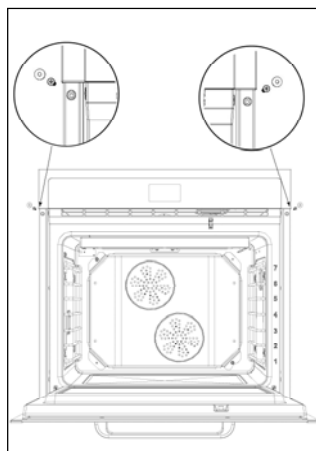

GETTING STARTED

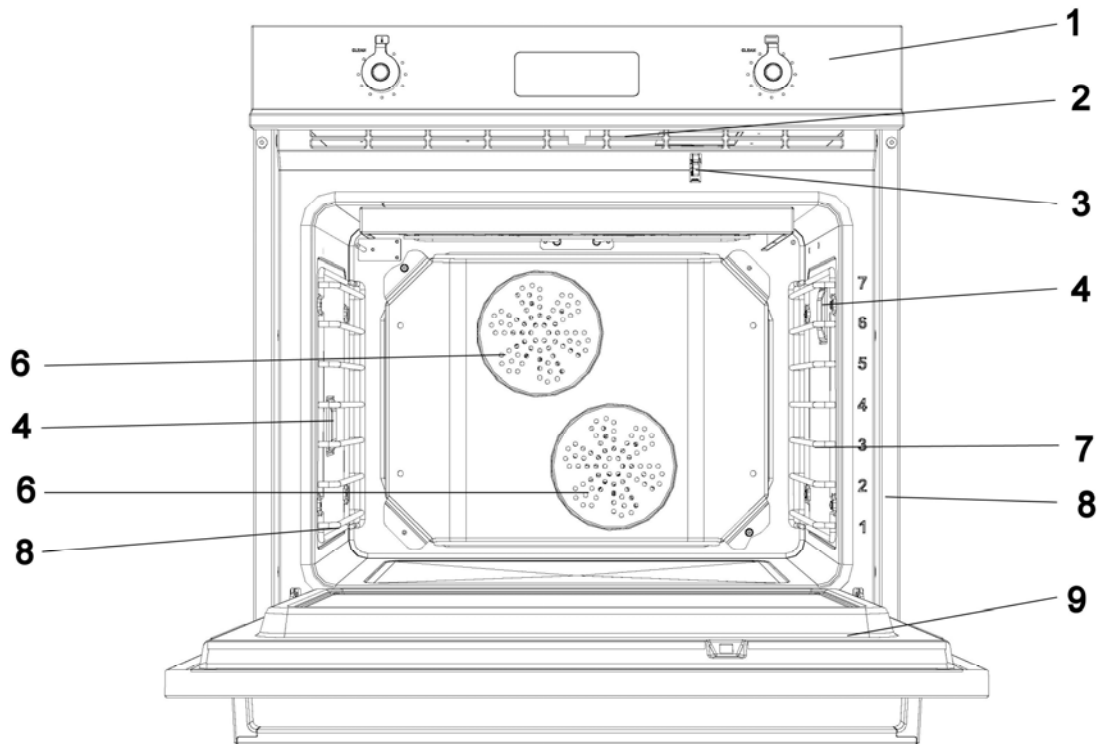

- 1 Control Panel (KNOBS only presents on PRO models)
- 2 Cooling exhaust
- 3 Self-clean cycle door lock
- 4 Lights
- 6 Convection fans
- 7 Seven level shelf supports
- 8 Data plate
- 9 Oven door

COOLING FANS

Two cooling fans are concealed in the upper portion of the oven. They activate each time the internal temperature reaches 390F (200C) and continue to operate until the temperature drops to 320F (160C). Therefore the cooling fans may be on after the oven has been turned off. When the temperature inside the oven is over 280F (140C), the cooling fans activate each time the door is opened in order to avoid that the hot air escaping the cavity enters in contact with the control panel. Cooling fans are always operated when a cleaning cycle is selected.

NOTE: COOLING FANS ARE DIFFERENT FROM THE CONVECTION SYSTEM FANS, WHICH ARE PLACED AT THE BACK OF THE OVEN CAVITY.

OVEN LIGHTS

The appliance is equipped with two oven lamps that light up when the oven door is opened or each time the oven is in operation. They are turned off during the cleaning cycle.

OVEN RACKS

Shelves are mounted on the appropriate guides situated on the sides of the oven compartment. Insert the shelf between top and bottom guide in any of the 7 positions available.

STEEL RACKS

Slide the racks onto the runners on both sides of the oven. The racks have non-tip safety notches, which prevent them from being pulled out completely while the oven is in use.

When inserting a rack, always check that the safety notches are at the back. To remove racks, raise them upwards and pull out.

FRONT INDICATOR LIGHTS

This appliance is equipped with 3 indicator lights on the front panel:

- C CLEAN/RED colour: on with door locked during cleaning cycle
- H HEATING/BLUE colour: on when cooking or cleaning temperature is reached, always on during functions Dehydrate-Proofing-Warming levels 1-2-3
- P PRE-HEATING/BLUE colour: on during pre-heating period; not active for functions Dehydrate-Proofing-Warming levels 1-2-3.

The indicator lights flash intermittently when an error is detected.

For explanation of errors, please refer to the chapter TROUBLESHOOTING GUIDE.

SOUND BUZZER

The appliance is equipped with a sound buzzer that emits a sound when the timer and the end of cooking are used.

OVEN CONVECTION FAN

The appliance is equipped with an oven fan mounted inside a circular heating element, protected by a fan shield on the back of the oven cavity; it operates each time that the oven operates in the functions ROASTING, TURBO, CONVECTION BROILER, CONVECTION BAKE and DEHYDRATE.

USING THE LCD DISPLAY

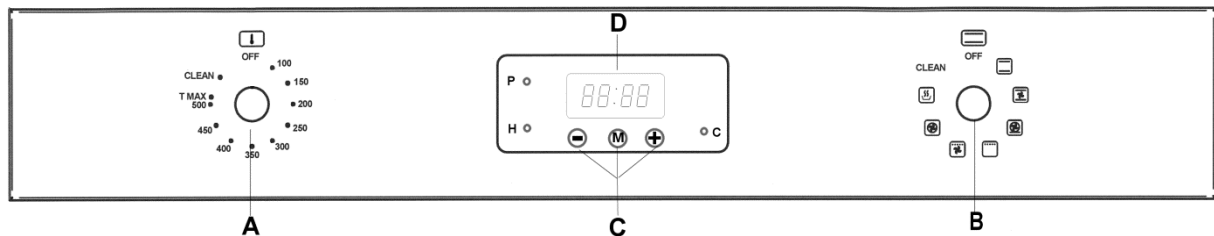

A Temperature knob B Cooking modes knob C Touch control areas D LCD Display

BEFORE USING THE OVEN

Before using the oven for preparing food:

- Remove the protective film from the oven door and control panel
- Remove all accessories from the oven
- Remove all stickers from the baking tray, from the roasting pan or from the interior cavity of the oven
- Remove all spacers and packing material from the interior of the oven cavity
- Make sure the room is properly ventilated
- Run the oven for 2 hours at 500F / 260C in turbo mode.

This pre-operating procedure will ensure that all internal residues burn off prior to preparing food.

OVEN COOKING

WARNING

Use Care When Opening Door. Let hot air or steam escape before removing or replacing food.

Do Not Heat Unopened Food Containers. Build-up of pressure may cause container to burst and result in injury.

Keep Oven Vent Ducts unobstructed.

Placement of Oven Racks. Always place oven racks in desired location while oven is cool. If rack must be moved while oven is hot, do not let potholder contact hot heating element in oven.

Do Not Clean Door Gasket. The door gasket is essential for a good seal. Care should be taken not to rub, damage, or move the gasket

Do Not Use Oven Cleaners. No commercial oven cleaner or oven liner protective coating of any kind should be used in or around any part of the oven.

Clean Only Parts Listed in manual.

Before Self-Cleaning the Oven. Remove broiler pan and other utensils.

CAUTION

Do not store items of interest to children in cabinets above a range or on the back guard of a range – children climbing on the range to reach items could be seriously injured.

DO NOT TOUCH HEATING ELEMENTS OR INTERIOR SURFACE OF OVEN

Heating elements may be hot even though are dark in colour. Interior surfaces of an oven become hot enough to cause burns. During and after use, do not touch, or let clothing or other flammable materials come into contact with the heating elements or interior surfaces of oven until they have had sufficient time to cool. Other surfaces of the appliance may become hot enough to cause burns, for example, oven vent openings and surfaces near these openings, oven doors, oven glass window.

USING THE LCD DISPLAY

At power on, the contact is opened. The display and AUTO symbol flashes and time of day starts from 0:00. Power on state with flashing daytime remains until time of day is set

SETTING TIME



Press PLUS (+) and MINUS (-) button simultaneously. At Power On, also MODE button is possible. Time of day can be set with PLUS or MINUS, while the colon between hours and minutes is flashing. When PLUS or MINUS is continually hold, the quick setting mode starts. If daytime setting mode is selected while an automatic program is active, the automatic program is cancelled.

When the symbol  is present the manual mode is activated, the oven can operate only using the functions and temperature knobs

MANUAL MODE

Once the cooking program is finished, to restore the manual mode, press M key for 2 seconds, the symbol  appear. The oven can operate only using the functions and temperature knobs.

TIMER

The purpose of the timer is just of a sound signal, which can be set for a max time of 23h59min. once elapsed the set time, the  symbol turns off and a sound signal is heard; this sound set off automatically in 7min, or you can stop it by pressing any key of the programmer. To set the timer press the M key for 2 seconds, or anyway just to see the  symbol blinking. Set the timer by using the + or - keys. Release the + or - key when you have matched your desired time. In a few seconds the current time appears on the display together with the symbol. The countdown starts immediately from now on.

SEMI-AUTOMATIC COOKING

Cooking time: Once having selected a cooking function and set the desired temperature, press the M key for a 2 seconds time to access the programming mode.

The  symbol appears. Release and press again the M key. On the display, the AUTO symbol starts blinking and the "dur" writing appears on the display, then it

changes to 0' 00. Set the cooking time with the - or + keys. (max available time: 10h). The selected time is automatically processed by the programmer in a few seconds, or you can also touch the M key many times just to see again the current time.

The AUTO and  symbols will be on the display. Once the set cooking time is finished, a sound will be heard and the oven automatically switches off. Please see the following paragraphs about how to disable the sound alarm and restarting the oven.

END OF COOKING

once having selected a cooking function and set the desired temperature, touch the M key to access the programming mode for at least 2 sec. the  symbol switches on. Release and touch again the M key.

On the display the AUTO symbol starts blinking and the writing "dur" appears. Touch again the M key. On the display the writing "End" appears. The last one changes few seconds after with the symbol 0' 00.

Set the end of cooking time with the keys - or +. (maximum available time: 10h00m). The selected time is automatically processed by the programmer in a few seconds, or you can also touch the M key many times just to see again the current time.

The cooking immediately starts, while on the programmer display the current time is shown again in a few seconds. The AUTO and  symbols will be on the display.

Once the set end of cooking time is finished, a sound will be heard and the oven automatically switches off. Please see the following paragraphs about how to disable the sound alarm and restarting the oven.

AUTOMATIC COOKING Set a cooking time following the instructions on the cooking time paragraph, then set the end of cooking time following the instructions on the previous paragraph. (Max available end of cooking time 24h). The oven automatically switches on at a determined time which is the difference between the end of cooking time and the cooking time.

During the waiting time before cooking, which goes from the oven start to the heating, on the display appears the AUTO symbol to show that an automatic program is on and the current time. The oven on is marked by the  symbol. Once the set end of cooking time is finished, a sound will be heard and the oven automatically switches off.

Please see the following paragraphs about how to disable the alarm and restarting the oven.

How to disable the sound alarm: To disable the sound just touch one of the keys.

Operating again the oven



Once a semi-automatic or automatic cooking has expired, on the display appear the current time and the blinking AUTO symbol. In this condition, the heating elements and the light bulb of the oven are disabled. To enable again the oven, just touch and keep the M key up to see the symbol  on the display and the AUTO symbol disappears.

OTHER FUNCTIONS

How to delete a cooking time (semi-automatic or Automatic)

To delete a semi-automatic or automatic cooking program, with the AUTO symbol on, touch together the - and + keys for at least 2 seconds or anyway up to see the  and the disabling of AUTO symbol.

How to delete the countdown timer

To delete the counting of the timer, which symbol is  touch the M key for at least 2 seconds or anyway up to see the  symbol blinking. Touch together the - and + keys.

Checking the function settings

The set or remaining time of every cooking function of the programmer can be recalled to the display by entering in program mode with the M key. Touch and keep the M key for almost 2 seconds or anyway up to see the  symbol. The remaining time appears on the display, or a series of zero numbers if the timer is disabled. Touch again the M key. On the display appears the "dur" writing, then alternately the remaining time or a series of zero number (disable timer). By touching again the M key, the end of cooking time appears together with the "End" writing.

How to change the current time or the sound level

With the programmer in standard mode, the (2) symbol is on, touch together the - and + keys for at least 2 seconds or anyway up to see the dot (3) blinking.

To update the hour on the display: touch the + or - keys.

To change the sound level: touch the + and - keys simultaneously for 2 seconds

than touch the M key. On the display appears the writing: Ton. followed by a number. Select with the - key your favorite sound level.

Note: number 1 is referred to the highest sound level. The available levels are 3.

Attention: Power cut causes the loss of any program, even the clock; that means the programmer will have to be set again.

OVEN FUNCTIONS SELECTOR

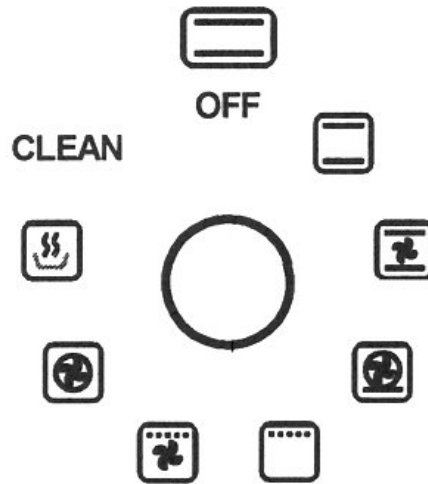

TEMPERATURE/CLEAN SELECTOR

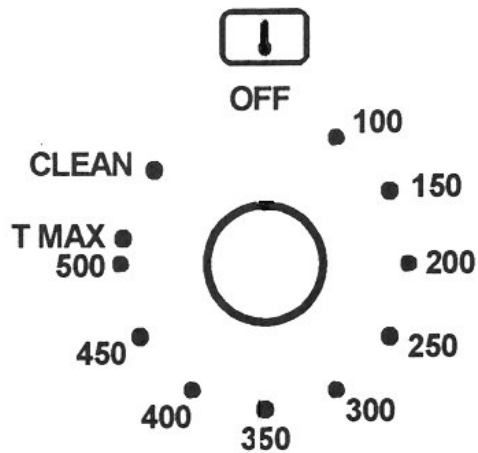

OVEN OPERATION

START

Select COOKING MODE by turning the right knob

Select COOKING TEMPERATURE by turning the temperature left knob

The oven will start PRE-HEATING. The end of pre-heating will be confirmed with a tone. Place the food in the oven when the desired temperature has been reached.









MODIFY/STOP



Modify COOKING MODE during cooking by turning the cooking mode knob

Modify COOKING TEMPERATURE during cooking by turning the temperature knob

Stop cooking by turning the COOKIN MODE knob and COOKING TEMPERATUIRE in the OFF position

COOKING MODES GUIDE

MODE	DETAILS	USE FOR/TIPS
BAKE 	Bake and broil elements ON Convection OFF Temperature 100F - 500F Use lower 2 shelf levels.	Soufflés Meringues Angel food cakes Cream puffs Cookies Cakes Cheesecakes, Pies Quiches Baked potatoes
CONVECTION BAKE 	Bake element ON at full power Broil element ON at moderate power Convection fan ON Temperature 100F- 500F Use several levels at the same time. NOTE: As a general rule, the temperature of a recipe not designed for baking in a convection oven should be lowered by 20F (15C)	Cookies Cakes Breads Rising dough Cheesecake Pies Quiches Baked potatoes Casseroles
CONVECTION 	Convection fan and convection element ON Use several levels at the same time. Temperature 100F - 500F NOTE: As a general rule, the temperature of a recipe not designed for baking in a convection oven should be lowered by 20 °F (15 °C.)	Gentle cooking of pastries, soufflés and cakes. At higher temperature use also for roasting meats and poultry.
TURBO 	Bake element ON at full power Convection element and fan ON at full power Temperature 100F – 500F Use shelf levels 2 and 3	Uniform cooking with strong heat from the bottom of pizza, focaccia and bread.
BROIL 	Broil element ON 4 power settings – LOW (1) to HIGH (4) The element is heated for the first 3 minutes at maximum power and then the power is reduced according to the selected power setting.	Brown food on the top side only. Turn food over if browning is required on both sides.
CONVECTION BROIL 	Broil element ON Convection fan ON 4 power settings – LOW (1) to HIGH (4) The element is heated for the first 3 minutes at maximum power and then the power is reduced according to the selected power setting.	Brown food on top and bottom side. This mode is preferred for browning food that is too delicate for turning such as fish. NOTE: The degree of browning on each side might be different.
DEHYDRATE 	to be used with temperature selector at 100°F (corresponding to an internal oven setup fixed temperature of 100°F)	Dehydrate food, flowers, vegetables.
PROOFING 	PROOFING to be used with temperature selector set at 150°F (corresponding to an internal oven setup fixed temperature of 100°F). Use any shelf level.	For best results, place dough in bowl and cover with a clean towel.

WARMING 	WARMING-Level 1 to be used with temperature selector set at 200°F (corresponding to an internal oven setup fixed temperature of 140°F)	
WARMING 	WARMING-Level 2 to be used with temperature selector set at 250°F (corresponding to an internal oven setup fixed temperature of 170°F)	
WARMING 	WARMING-Level 3 to be used with temperature selector set at 300°F (corresponding to an internal oven setup fixed temperature of 220°F)	
CLEAN	CLEAN to be used with temperature selector set at CLEAN for automatic self-cleaning cycle (see proper chapter "SELF CLEANING THE OVEN")	

TIPS FOR BEST RESULTS - BAKING
CHECK PACKAGE DIRECTIONS

FOOD	PAN SIZE	TEMPERATURE	COOKING TIME (minutes)	LEVEL
Cookies	12"x15" Cookie Sheet	370°	8 to 12	2..5
Layer Cakes	8"or 9"Round	350°	25 to 35	2..5
Sheet Cakes	9"x13" Pan	350°	30 to 40	2..5
Bunt Cakes	12 Cup	320°	60 to 75	2..5
Brownies, Bar Cookies	9"x9" Pan	320°	20 to 25	2..5
Biscuits	12"x15" Cookie Sheet	420°	10 to 15	2..5
Quick Bread	8"x4" Loaf Pan	350°	55 to 70	2..5
Muffins	12 cup Muffin Pan	420°	14 to 19	2..5
Fruit Pies	9" Diameter	420°	35 to 45	2..5
Fruit Cobblers	9"x9" Pan	400°	25 to 30	2..5
Yeast Bread	8"x4" Loaf Pan	370°	25 to 30	2..5
Dinner Rolls	9"x13" Pan	400°	12 to 18	2..5
Cinnamon Rolls	9"x13" Pan	370	25 to 30	2..5
Yeast Cake	12"x15" Cookie Sheet	400°	20 to 30	2..5

TIPS FOR BEST RESULTS - WARMING

FOOD	TEMPERATURE
Beef	150°F (70°C)
Bacon	200° -225°F (90 - 110°C)
Biscuits and Muffins (covered)	175°-200°F (80 - 90°C)
Casserole (covered)	175°-200°F (80 - 90°C)
Fish and Seafood	175°-200°F (80 - 90°C)
Deep Fried Foods	200° -225°F (90 - 110°C)
Gravy or Cream Sauces (covered)	175°F (80°C)
Lamb and Veal Roasts	175°-200°F (80 - 90°C)
Pancakes and Waffles (covered)	200° -225°F (90 - 110°C)
Potatoes Baked	200°F (110°C)
Mashed (covered)	175°F (80°C)
Pies and Pastries	175°F (80°C)
Pizza (covered)	225°F (110°C)
Pork	175°-200°F (80 - 90°C)
Poultry (covered)	175°-200°F (80 - 90°C)
Vegetables (covered)	175°F (80°C)

TIPS FOR BEST RESULTS - DEHYDRATE

FOOD	PREPARATION	APPROXIMATE TIME (hrs)	DONE WHEN...
Apples	Cut in ¼" slices and dip in 1/4 cup lemon juice + 2 cups water solution	11-15	Slightly pliable
Bananas	Cut in ¼" slices and dip in 1/4 cup lemon juice + 2 cups water solution	10-15	Soft, pliable
Cherries	Wash and towel dry. Remove pits	10-15	Pliable, leathery, chewy
Orange peels and slices	Peel and cut in 1/4" slices	Peels:2-4 Slices: 12-16	Orange peel: dry and brittle. Orange slices: skins are dry and brittle, fruit is slightly
Pineapple rings	Towel dry	Canned: 9-13 Fresh: 8-12	Soft and pliable
Strawberries	Wash and towel dry. Cut in 1/2" slices. Place skin (outside) down on rack	12-17	Dry, brittle
Red peppers	Wash and towel dry. Remove stems, chop coarsely about 1" pieces	16-20	Leathery with no moisture inside
Mushrooms	Wash and towel dry. Cut off stem end. Cut into 1/8" slices	7-12	Tough and leathery, dry
Tomatoes	Wash, drain well and towel dry. Cut in 1/8" slices.	16-23	Dry, brick red colour
Oregano, sage, parsley, thyme, fennel	Rinse and dry with paper towel	3-5	Crisp and brittle
Basil	Use basil leaves 3 to 4 inches from top. Spray with water, shake off moisture and pat dry	3-5	Crisp and brittle

SELF-CLEANING CYCLE

The self-cleaning mode of your new range features a pyrolytic self-cleaning cycle. When set to the CLEAN mode, the oven reaches a high temperature that burns off all food residues from the inside of the oven.

It is common to see smoke and/or flames during the clean cycle, depending on the content and amount of greasy residues in the oven. If the flame persists, turn off the oven and allow it to cool before opening the door and wipe off the excessive residues.

At the end of the CLEAN cycle, some grey ash or burned residue may remain inside the oven. This is a mineral deposit that does not burn or melt. The amount of ash depends on how heavily soiled the oven was before it was cleaned. It is easily removed, when the oven is cold, using a damp paper towel, sponge, or cloth.

Wipe off any smoke residue that remains on the front frame with a cleaning product suitable for oven cavity cleaning. If stains remain, use a mild liquid cleaner. The amount of smoke stain is directly related to the amount of food residues in the oven cavity before the start of the self-cleaning cycle.

DESCRIPTION

In the self-cleaning cycle, the oven cavity is heated to very high temperatures to burn off any residue on the oven interior. After the cleaning cycle, any burnt off residue is transformed to ash and can be easily wiped out with a damp sponge.

Spilled fruit juices may permanently discolour surfaces. This discoloration is permanent but will not affect the efficiency of the enamel.

If the oven is not cleaned regularly, debris may become extremely difficult to remove even with the CLEAN function.

PREPARE

Before starting the CLEAN function:

- Remove large pieces of debris and grease deposits from the interior of the oven cavity. Debris and grease can ignite at high temperatures.
- Remove all accessories from the oven. The high temperature reached during the cycle will damage the accessories.

DOOR LOCK

When the CLEAN cycle starts, the automatic door lock cycle begins. Check the door to confirm that it is locked. You can stop the self-cleaning cycle by turning the function selector to the OFF position. The CLEANING light will turn off only after the oven has cooled below 500°F and the automatic door lock has completed its cycle to the open position.

NOTE: MAKE SURE THAT THE OVEN DOOR IS LOCKED AT THE BEGINNING OF THE SELF-CLEANING CYCLE.

START

1. Check that the oven cavity is completely empty and the oven door correctly closed.
2. Select CLEAN fu on oven function selector.
3. Set temperature selector to CLEAN.

After these 3 steps the cooling fans will activate, the oven door will lock automatically after 60 seconds and both the pre-heating and clean light indicators will turn on.

As soon as clean light turns on check to ensure that the oven door is correctly locked.

The self-cleaning cycle lasts approximately 2-2 ¼ hours; 30-40 minutes for pre-heating the oven (pre-heating and clean light both on), 60 minutes for actual cleaning (heating and clean light both on), 30-35 minutes for cool-down (only clean light on).

When the CLEAN light is turned off the oven door is unlocked. This will happen when the oven temperature drops below 460-500°F about.

At the end of the cycle turn both the oven mode selectors and the temperature to the OFF position.

CAUTION

The interior of the oven will still be at high temperature when the automatic lock is released – USE MAXIMUM CAUTION TO AVOID BURNS.

CLEANING THE OVEN

FRONT

Clean spills from the front of the appliance immediately. Spills may cause discoloration of the glass and steel surfaces.

Clean the front of the appliance with a clean sponge or cloth, liquid dish soap and warm water. Alternatively, use a clean, damp microfiber cloth and then dry with a soft cloth.

All surfaces are vulnerable to scratching. Scratches can lead to shattering of the glass surface.

All surfaces can become discoloured or changed if they come into contact with unsuitable cleaning agents.

In PRO model the display is protected with a transparent glass which is very delicate. Avoid contact with cleaning agents. Do not rub the surface. Swipe delicately with a mild cleaning agent and dry with a clean cloth.

INTERIOR

Caution: Danger of burns! Allow the oven to cool before cleaning.

Clean the oven surface with a solution of hot water, liquid dish soap and a sponge or soft nylon brush.

Do not use abrasive cleaning agents, hard brushes, metal scouring pads, steel wool, knives or other abrasive materials.

Avoid cleaning the gasket around the interior (sealing the door glass pane). It is made from glass fiber and will get damaged if rubbed or scrubbed.

Do not use oven spray on any part of this oven.

Tips

The porcelain enamel finish of the cavity is acid resistant, but not acid proof. Acidic food, such as citrus juices, tomatoes, rhubarb, vinegar, alcohol or milk, should be wiped off and not allowed to bake onto the porcelain during the next use.

Remove the oven racks when cleaning the interior of the oven.

The heating elements in the oven do not require cleaning; the elements burn themselves clean when the oven is in use. Elements are permanently connected. It is not necessary to clean the broiler shield above the broil element.

To avoid surface damage from cleaning, do not use any of the following:

- cleaning products that contain washing soda, ammonia, acids, or chlorine
- lime removers
- scouring cleansers, e.g., scouring powder, scouring liquid, pumice stones
- solvent-based cleansers
- stainless steel cleaners
- dishwasher detergents
- oven sprays
- glass cleaners
- scouring sponges or brushes, such as pot scrubbers
- sharp metal scrapers

ACCESSORIES

Wash with soapy water and a sponge. Rinse under running water.

REPLACING THE OVEN LIGHTS

WARNING!

Disconnect power before servicing unit.

To replace the oven light bulb, remove the protection cap. It is not necessary to remove the rack supports.

NOTE: Touching the bulb with fingers may cause the bulb to burn out. Always use protective gloves or use a cloth to remove the bulb.

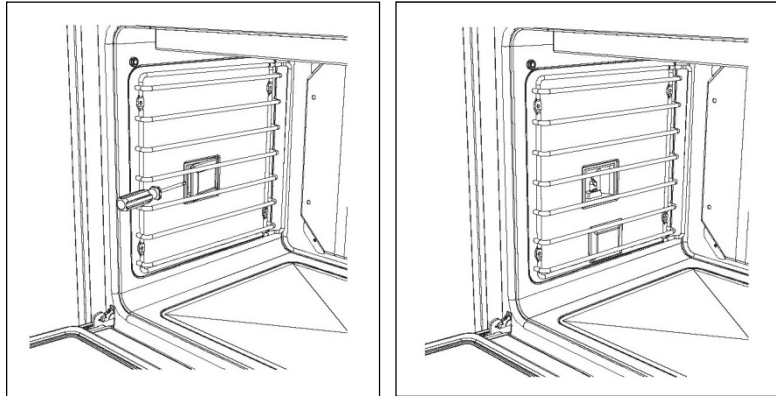

TROUBLESHOOTING GUIDE

OVEN PROBLEM	POSSIBLE CAUSES AND/OR REMEDY
Oven does not function	Range is not connected to electrical power. Ask a professional to check power circuit breaker, wiring and fuses.
Self-clean cycle does not activate	Door is not shut tight and door latch cannot lock
Door does not open	Oven is still in self-clean mode. Door latch will release when safe temperature is reached.
Oven light does not work	Light bulb is burned out. Oven is not connected to power. Clean cycle is on.
Oven door is locked and will not release after cooling	Turn the oven off at the circuit breaker and wait 5 minutes. Turn breaker back on. The oven should reset itself and will be operable.
Oven is not heating	Check the circuit breaker or fuse box to your house. Make sure there is proper electrical power to the oven. Make sure the oven temperature has been selected.
Oven light is not working properly	Replace or reinsert the light bulb if loose or defective.
Oven light stays on	Check for obstruction in oven door. Check to see if hinge is bent.
Cannot remove light cover	There may be debris/spillage around the lens cover. Wipe lens cover area with a clean dry towel prior to attempting to remove the lens cover.
Broil does not work	Temperature control knob is rotated too far past broil position (500°F); PRE-HEATING indicator will light intermittently
PRE-HEATING indicator lights up intermittently and sound alarm on	This is a FAULT alarm indicating the failure of the cooling fan/s. Try resetting by turning both selectors to the OFF position. If the error is not repaired, call a qualified technician for diagnosis and repair. If not repaired, this error indicator will appear again within 10 seconds once the oven is activated in any functions for which cooling fans are required to operate, preventing the use of the oven. Set both selectors to OFF position and call a qualified technician for repair.
HEATING indicator light turned on intermittently and with sound alarm on	This is a FAULT indicating failure of the oven sensor temperature probe; in this case cooling fans will start automatically. To reset, switch both selector to the OFF position. To stop buzzer and light indicator, disconnect the appliance from the main electrical supply and call a qualified technician for repair.
CLEAN indicator light on intermittently and sound alarm on	Electrical power failure happening during cleaning cycle operation; cleaning cycle interrupted; cooling fans remains both activated; the error will be reset by putting two selectors in OFF position; repeat cleaning cycle if needed after 3-4 hours.
CLEAN indicator light turned on intermittently, sound alarm off	Interruption/Stop of an incomplete cleaning cycle due to a intentional or accidental displacement of one of the two oven selectors from CLEAN position during cleaning cycle operation; put both selectors in OFF position, wait that door latch unlocks the door when oven temperature is dropped below 500°F(260°C) and then re-select a desired oven function.
PRE-HEATING indicator light on intermittently, sound alarm on	Wrong temperature knob selection in oven functions BROILER or CONVECTION BROILER (temperature knob positioned not at 500°F position, over Tmax or under 450°F position); select OFF position and then 500°F on temperature selector; Or Wrong temperature knob selection for oven functions BAKE, CONVECTION BAKE; TURBO, CONVECTION (temperature knob positioned over Tmax=500°F position); select OFF position and then the desired temperature under Tmax position on temperature selector.



BERTAZZONI SpA
Via Palazzina 8
42016 Guastalla RE
ITALY

WWW.BERTAZZONI.COM